

HITACHI



**Hitachi Top Load
Washing Machine**

The Art of Ease





Surprisingly Bright!

Ultra Power Powerful Jets and 4-Step Washing*1

Hitachi top loading washing machines remove dirt and stains with powerful water jets and 4-step washing.

Powerful Jets

Besides agitation of clothes with a pulsator, powerful water jets reach items at various water levels and circulate them vertically and horizontally for a multi-directional washing effect.

4-Step Wash

Thoroughly penetrates deep into fabrics to effectively remove stubborn stains by controlling the water level to dissolve the detergent in 4 steps and to maximize cleaning power.



Clean Inside Auto Self Clean-The Tub Stain Fighter

**AUTO
SELF
CLEAN**

99% Mould & Bacteria Reduction

A shower of clean water cleans both the tubs as the stainless steel tub rotates at high speed to powerfully agitate water in the tub and clean off dirt.



With Auto Self Clean

Without Auto Self Clean

○Tested by Kitasato Research Center for Environmental Science.
 ○Document Number: 26_0100 ○Test method: Measurement of the reduction rate of germs smeared on plates that are attached to the outer tub and drum. ○Means for germs removal: Use of the Auto Self Clean function.
 ○Test objects: Outer tub and drum. ○Test result: Germs reduction rate: 99%.
 ○Document Number: 26_1100 ○Test method: Confirmation of the inhibitory effect of mould growth on medium plates that are attached to the outer tub and drum. ○Means for preventing mold growth: Use of the Auto Self Clean function. ○Test objects: Outer tub and drum. ○Test result: Mould reduction rate: 99%

*1 Applies to Dynamics-Stream Wash Series & Air Jet Dry Series only.
 *2 Images are for Dual Jet Series.

10-13.5kg



Simplify Your Laundry Routine with Top-Loading Efficiency

New Hitachi Top Loading Washing Machine is here to redefine your laundry experience. Engineered for top-tier efficiency and convenience, it pampers your clothes while delivering a thorough cleaning. Simplify your laundry routine and enjoy an effortless and effective washing experience in the comfort of your home.



Half Load Programme

Designed for short and regular laundry convenience, the Half Load Programme^{*1} washes up in approximately 29 minutes.



Speed Wash Programme

Combining speed and care to keep your everyday clothing and leisure wear fresh and ready, the Speed Wash Programme^{*2} is optimised to wash up in just 20 minutes.



Dual Waterfall with Efficient Interior Impeller Design

The innovative Dual Waterfall feature is purposefully designed with a two-tier waterfall channel that works with both high and low wash loads, ensuring extensive coverage for your clothing. For ultimate clothing care and optimal washing efficiency, the interior impeller creates strong water movement help reduce washing time, decrease water usage by 17%^{*3}, and enhance energy efficiency by 10%^{*3}.

Hand Wash Mode

With the convenient built-in water faucet for hand washing^{*4}, you can pretreat stained or soiled clothing, ensuring a careful and thorough approach to your delicate items, while preventing them from mingling directly with other garments during laundry.



Stain Programme

Two intelligent stain removal programmes^{*4} smartly treat everyday stains such as sauces, mud, and sweat as well as more heavily soiled items of clothing by adjusting water temperature, soak time, and detergent concentration.

^{*1} Based on a maximum load weight of 6 kg. | Half Load programme test according IEC 60335.
^{*2} Based on a maximum load weight of 2 kg. | Speed Wash programme test according IEC60456.

^{*3} Normal programme performance test according IEC standard.
^{*4} Tested by Arcelec Hitachi Home Appliances.

Tangle Free Finish

The unique tangle-free finish¹ minimises the tangling and twisting of clothes following the completion of a cycle, making it ideal for delicate fabrics. Additional movements help to carefully untangle laundry, resulting in easier unloading.

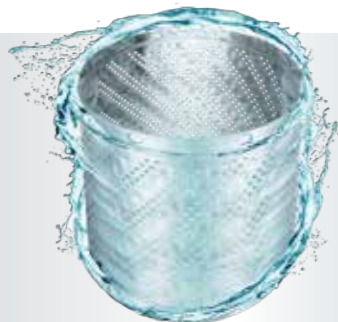

Auto Self Clean

Following the completion of each washing cycle, the Auto Self Clean feature uses drum rotation and automatically cleanse both the interior and exterior tubs, effectively reducing dirt, mould & bacteria ensure cleaning is maintained.



Inverter Motor

The inverter motor is designed for energy efficiency, delivering optimal washing performance while saving on energy. Durable technology also reduces noise and vibration for a quieter laundry experience.

Soaking

The soak function² is designed to effortlessly tackle heavily soiled clothes. It works by gently loosening tough stains before the main wash cycle begins. The drum fills with water, immerses clothing in detergent, and provides gentle agitation for a set time, ensuring a thorough pre-treatment.

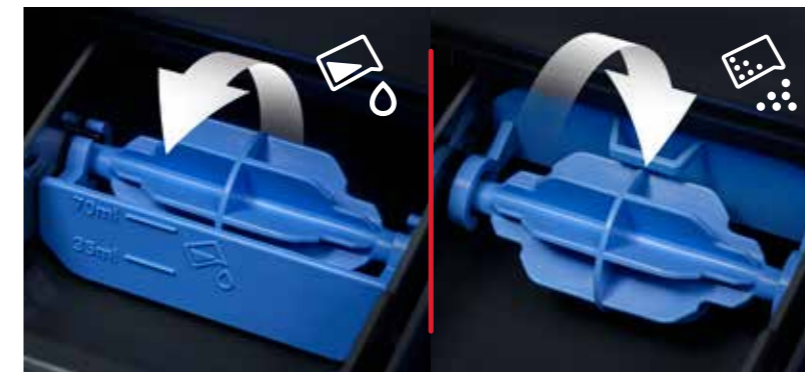

Flexible Detergent Drawer

The Flexible Detergent Drawer², equipped with a rotary mechanism, accommodates both liquid and powder detergents for seamless and smooth dispensing. Intuitive indicators guide you to the optimal detergent measurement for your selected wash programme, ensuring efficient dissolving and a hassle-free laundry experience.

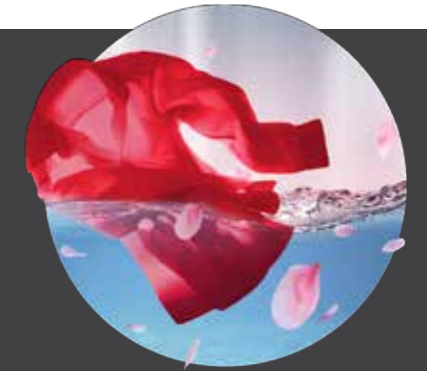

Fragrance

Savour the feeling of fresh-scented laundry with Fragrance programme². With longer exposure to fabric softener, your clothing is beautifully fragrant every single wash, ensuring a longer-lasting, delightful freshness.



Wash Mode Function

Discover more versatility with a comprehensive range of washing modes. From quick and convenient washes to hygiene-focused cycles and targeted stain removal programmes. You can even feel at ease with your delicate fabrics, knowing every load will be gently laundered with care.



Air Jet Dry

Enjoy shorter drying times with the Air Jet Dry² feature, as high-speed drum rotation efficiently reduces moisture from your laundry, ensuring faster drying for your clothing.



Ease of Loading

Simplify your laundry routine with a top-loading washing machine thoughtfully designed for seamless loading³ convenience.



Rear Control Panel

The rear control panel³ is thoughtfully designed for ergonomic convenience, ensuring that all controls are within easy reach. The inclined panel design remains dry when unloading clothes, thus ensuring practical functionality.

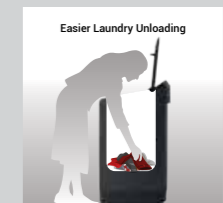

Easy to Reach

Experience easy laundry unloading with the shallower depth design that maintains generous capacity without the need for overreaching³.

¹ Tangle Free Finish is tested by ArceLIK Hitachi Home Appliances.
² Tested by ArceLIK Hitachi Home Appliances.

³ Usability test.

Glass Durability

The tempered glass lid^{*1} is highly durable and not only resists damage and scratches but also adds a touch of elegance to your laundry space.



Lid Lock

The top-loading washing machine features a secure lid lock^{*2} that remains in place until the washing cycle completes, ensuring safe and uninterrupted operation for your peace of mind.



Soft Close

The soft-closing lid^{*2}, designed for both safety and practicality, adds a touch of serenity to your laundry rituals. Closing gently and quietly allows you to effortlessly continue with your tasks, even when carrying a laundry basket, for a comfortable and convenient laundry experience.



LTL 10MVW0T1 10kg

Features

- Dual Waterfall
- Air Jet Dry
- Inverter Motor
- Auto Self Clean
- 8 Programmes
- Handwash Mode
- Stain Removal
- Yellowing Removal
- Easy Dissolver
- Tangle-Free Finish
- Delay Timer
- Child Lock



Graphite Gray

Dimensions (mm)

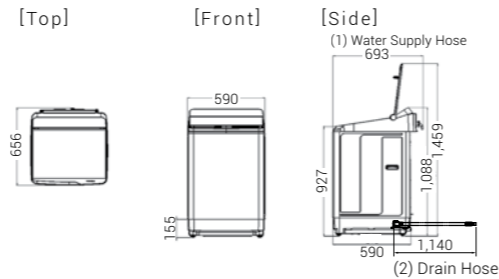

LTL 12MVW0T 12kg

Features

- Dual Waterfall
- Air Jet Dry
- Inverter Motor
- Auto Self Clean
- 8 Programmes
- Handwash Mode
- Stain Removal
- Yellowing Removal
- Easy Dissolver
- Tangle-Free Finish
- Delay Timer
- Child Lock



Graphite Gray

Dimensions (mm)

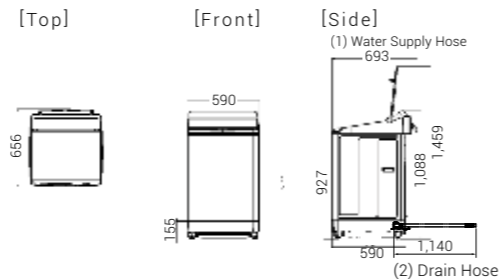

LTL H3MVW0T 13.5kg

Features

- Dual Waterfall
- Air Jet Dry
- Inverter Motor
- Auto Self Clean
- 8 Programmes
- Handwash Mode
- Stain Removal
- Yellowing Removal
- Easy Dissolver
- Tangle-Free Finish
- Delay Timer
- Child Lock



Graphite Gray

Dimensions (mm)

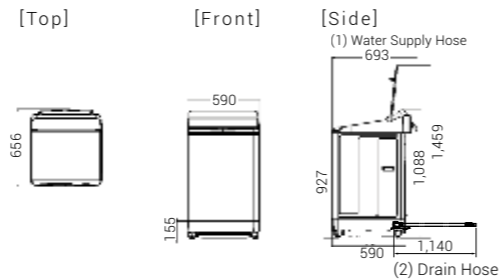

8-9kg

Smart Wash

Save water with our load-sensing technology. The machine automatically detects the load size and adjusts the water level accordingly, delivering a flexible and efficient wash every time.

Auto Balancer

Auto Balancer detects when the machine is unbalanced and automatically rearranges the clothes to ensure even load distribution, reducing vibration and noise for improved performance and durability.



*1 Usability test.
*2 Tested by Arcelek Hitachi Home Appliances.

* Images are for illustrative purposes only.



Soaking Function

The soak¹ function is designed to effortlessly tackle heavily soiled clothes. It works by gently loosening tough stains before the main wash cycle begins. The drum fills with water, immerses clothing in detergent, and provides gentle agitation for a set time, ensuring a thorough pre-treatment.

Soft Close

The soft-closing lid designed for both safety and practicality, adds a touch of serenity to your laundry rituals. Closing gently and quietly allows you to effortlessly continue with your tasks, even when carrying a laundry basket, for a comfortable and convenient laundry experience.

Easy to Reach

Experience easy laundry unloading with the shallower depth design that maintains generous capacity without the need for overreaching.



* Images are for illustrative purposes only.

Glass Durability

The durable tempered glass lid² resists damage and scratches while its wider glass area enhances drum visibility and add a touch of elegance to your laundry space.

Air Jet Dry

Enjoy shorter drying times with the Air Jet Dry³ feature, as high-speed drum rotation efficiently reduces moisture from your laundry, ensuring faster drying for your clothing.

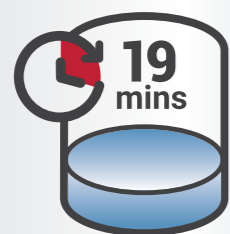

Speed Wash Programme

Combining speed and care to keep your everyday clothing and leisure wear fresh and ready, the Speed Wash Programme⁴ is optimised to wash up in just 19 minutes.

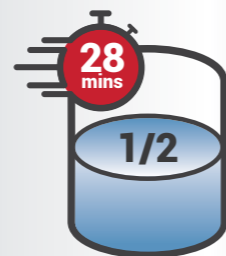

Half Load Programme

Designed for short and regular laundry convenience, the Half Load Programme⁵ washes up in approximately 28 minutes.

LTL 08M00 8kg

Features

- Air Jet Dry
- 8 Programmes
- Display Timer
- Child Lock

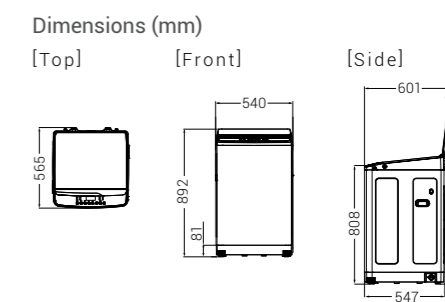

LTL 09M00 9kg

Features

- Air Jet Dry
- 8 Programmes
- Display Timer
- Child Lock

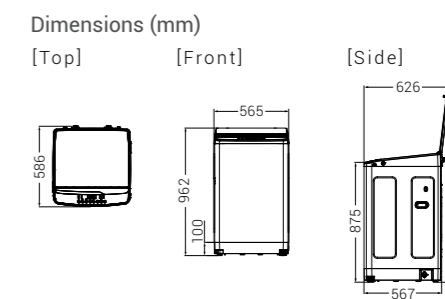

Lid Lock

The top loading washing machine features a secure lid lock that remains in place until the washing cycle completes, ensuring safe and uninterrupted operation for your peace of mind.



Ease of Loading





Simplify your laundry routine with a top loading washing machine thoughtfully designed for seamless loading convenience.



*1 Internal testing: Performance may vary based on fabric, detergent, and washing conditions.
 *2 The standard according to IEC 60335.
 *3 Performance may vary based on fabric, load size, and spinning conditions.

*4 Based on a maximum load weight of 2 kg.
 *5 Based on a maximum load weight of 4 kg (for 7/8kg model) and 5 kg (for 9/10kg model).

SPECIFICATIONS

Top Loading Washer		Smart Wash Series		Dual Waterfall Series		
						
Model		LTL 08M00	LTL 09M00	LTL 10MVW0T1	LTL 12MVW0T	LTL H3MVW0T
Type		Top Loading Washer	Top Loading Washer	Top Loading Washer	Top Loading Washer	Top Loading Washer
Capacity	Washing Capacity	8kg	9kg	10kg	12kg	13.5kg
General	Colour	Graphite Gray	Graphite Gray	Graphite Gray	Graphite Gray	Graphite Gray
	Motor Type	AC Motor	AC Motor	Inverter	Inverter	Inverter
	Lid Colour	Black	Black	Black	Black	Black
	Handle Colour	Black	Black	Black	Black	Black
	Interface	Front Control Panel with LED Display	Front Control Panel with LED Display	Rear Control Panel with LED Display	Rear Control Panel with LED Display	Rear Control Panel with LED Display
	Max Spin Speed (RPM)	760	730	750	750	750
	Tub Material	Stainless Steel	Stainless Steel	Stainless Steel	Stainless Steel	Stainless Steel
	Water Levels	10	10	Max. 12	8	8
	Water Inlets	Single	Single	Single	Single	Single
	Features / Functions	Dual Waterfall	—	—	●	●
Drum Design		Spirally Type Impeller & Water Cube Drum Surface	Spirally Type Impeller & Water Cube Drum Surface	New Impeller & Drum Design	New Impeller & Drum Design	New Impeller & Drum Design
Handwash Mode		—	—	●	●	●
Auto Self Clean		—	—	●	●	●
Stain Removal Program		—	—	●	●	●
Yellowing Removal		—	—	●	●	●
Easy Dissolver		—	—	●	●	●
Detergent Drawer		Powder / Liquid Detergent	Powder / Liquid Detergent	Powder / Liquid Detergent	Powder / Liquid Detergent	Powder / Liquid Detergent
Soft Closing Top Lid		●	●	●	●	●
Wash Modes		Gentle / Normal / Heavy	Gentle / Normal / Heavy	Gentle / Normal / Heavy	Gentle / Normal / Heavy	Gentle / Normal / Heavy
Programmes	Additional Soak Time	4 levels	4 levels	2 levels	2 levels	2 levels
	Fragrance Function	—	—	●	●	●
	Air Jet Dry	●	●	●	●	●
	Time Delay	●	●	●	●	●
	Child Lock	●	●	●	●	●
	1	Normal	Normal	Normal	Normal	Normal
	2	Powerful	Powerful	Speedwash	Speedwash	Speedwash
	3	Half Load	Half Load	Half Load	Half Load	Half Load
	4	Speed Wash	Speed Wash	Powerful	Powerful	Powerful
	5	Delicate	Delicate	Stain	Stain	Stain
6	Jeans	Jeans	Duvet	Duvet	Duvet	
7	Duvet	Duvet	Delicate	Delicate	Delicate	
8	Tub Clean	Tub Clean	Tub Wash	Tub Wash	Tub Wash	
Dimensions (WxHxD, mm)		540×892×565	565×962×586	590×1,088×656	590×1,088×656	590×1,088×656
Weight (Net / Gross, kg)		30.5 / 34	35 / 39.5	37 / 42	38 / 43	38 / 43

*1 The Fuzzy Programme is a standard programme.

*2 Including drain hose and water supply hose.